

DEVILBISS

AUTOMOTIVE REFINISHING

EN



SB-E-2-850 ISS.01

CE Ex II 2 G X

Technical Bulletin

SRI PRO range of Gravity Spray Guns for spot repairs and small areas.



Table of Contents

Topic	Page
EC Declaration of Conformity	3
Part Numbers	3
Operational Description	3
Kit contents	4
Construction Features	4
Materials of Construction	4
Specifications & Technical Data	4
Safety Precautions	5
Parts List	6
Exploded parts View	7
Installation, Operation, Preventive Maintenance & Cleaning	8
Parts Replacement/Maintenance	9
A. Servicing Air Valve	9
B. Replacing Air Valve	10
C. Needle Packing, Fluid Insert, Spreader Valve Assembly	11
D. Spray Head Seal	12
E. Chart 1 – Air Caps, Chart 2 – Fluid Nozzles & Fluid Needles	13
Troubleshooting Possible Problems in Operation	14
Accessories	16
Warranty	16

EC Declaration of Conformity

We, ITW Finishing UK, Ringwood Rd, Bournemouth, Dorset, BH11 9LH, UK, as the manufacturer of the Spray gun model **SRI-PRO**, declare, under our sole responsibility, that the equipment to which this document relates is in conformity with the following standards or other normative documents:

BS EN 292-1 PARTS 1 & 2: 1991, BS EN 1953: 1999; and thereby conform to the protection requirements of Council Directive 98/37/EEC relating to Machinery Safety Directive, and;

EN 13463-1:2001, council Directive 94/9/EC relating to Equipment and Protective Systems intended for use in Potentially Explosive Atmospheres protection level II 2 G X. This product also complies with the requirements of the EPA guidelines, PG6/34. Transfer efficiency certificates are available on request.



B. Holt, Vice President
1st Dec 2008

ITW Finishing Systems and Products reserve the right to modify equipment specification without prior notice.

Part Numbers

The ordering code for the SRI PRO Spray gun is;

e.g. SRIPRO-TS1-10 where;

TS1	=	TS1 Aircap. Alternatives are HS1, and RS1 (round spray)
10	=	10 Nozzle. Alternatives are 08,12 or 14

Operational Description

This SRI PRO Spray Gun is a professional quality gun designed with both high volume, low pressure (HVLV) technology or EPA compliant, Trans-Tech[®] technology. HVLV Technology reduces overspray and limits air cap pressure to 0.7 bar (10 psi). Trans-Tech[®] complies with EPA by obtaining transfer efficiency above 65%.

IMPORTANT: These Sprayguns are suitable for use with both waterbased and solvent based coating materials. These guns are not designed for use with highly corrosive and/or abrasive materials and if used with such materials it must be expected that the need for cleaning and/or replacement of parts will be increased. If there is any doubt regarding the suitability of a specific material, contact your DeVilbiss Distributor or DeVilbiss direct.

NOTE: This gun is not to be used with halogenated hydrocarbon solvents or cleaning agents such as 1,1,1,-Trichloroethane or methylene chloride. These solvents can react with the aluminium components used in this gun and cup. The reaction can become violent and lead to an equipment explosion.

Kit contents (all models)			
1	SRI PRO Gravity Feed Spraygun	1	Spanner (6mm hex and 10mm A/F)
1	SRI Gravity feed cup	1	Torx/Flat blade screwdriver
1	Cup Filter	1	Small Cleaning Brush
1	Set of 4 coloured identification rings	1	Large Cleaning Brush
1	Funnel	1	Service bulletin CD

Construction Features			
1	Air Cap (nickel plated brass for long durability)	10	Fan Air Adjustment (stepless regulation for fan to round spray)
2	Air Cap Retaining Ring (allows easy rotation of air cap)	11	Fluid Adjustment (stepless regulation of fluid volume)
3	Fluid Nozzle (ideal for automotive topcoat systems)	12	Interchangeable Colour ID System (4 coloured rings supplied)
4	Fluid Needle (grooved stem for easy removal)	13	Anodised, forged aluminium gun body (ergonomic, good looking & durable, easy to
5	Fluid Inlet (7/16" – 14 UNC thread) – accepts DeVilbiss SRI cup systems	14	125cc Acetal Cup (easy clean, anti-static)
6	Air Inlet (universal thread, accepts G 1/4 & 1/4 NPS)	15	Cup Lid with Drip Free Vent (avoid drips)
7	Self Adjusting Needle Packing (for trouble free operation)	16	Air Valve (design offers low pull force & low pressure drop)
8	Trigger (ergonomic for comfort)	17	Gun acceptable for waterborne and solvent borne applications
9	Trigger Stud & Screw (easy replacement design)		

Materials of Construction	
Gun Body	Anodised aluminium
Air Cap,	Nickel plated brass
Fluid Nozzle, Fluid Needle, Fluid Inlet, Trigger Stud	Stainless steel
Springs, Clips, Screws	Stainless steel
Seals, Gaskets	Solvent resistant
Trigger	Chrome plated steel
Air Inlet, Body Bushing, Spreader Valve Body, Air Valve Nut, Air Cap Retaining Ring, Knobs	Chrome plated brass
Air Valve Assembly	Stainless Steel, HPDE

Specifications & Technical Data	
Air Supply Connection	Universal 1/4" BSP and 1/4" NPS male
Maximum Static Air Inlet Pressure	P1 = 12 bar (175 psi)
Gun Air Inlet Pressure for HVLP (HS1) and Trans-Tech® (TS1, and RS1) with gun triggered.	2.0 bar (29 psi)
Fluid Supply Connection	7/16 – 14 UNC
Service Temperature	0 to 40°C (32 to 104°F)
Gun Weight (gun only) (with cup)	425 g 485 g



SAFETY WARNINGS

Fire and explosion



Solvents and coating materials can be highly flammable or combustible when sprayed. ALWAYS refer to the coating material supplier's instructions and COSHH sheets before using this equipment.



Users must comply with all local and national codes of practice and insurance company requirements governing ventilation, fire precautions, operation and house-keeping of working areas.



This equipment, as supplied, is NOT suitable for use with Halogenated Hydrocarbons.



Static electricity can be generated by fluid and/or air passing through hoses, by the spraying process and by cleaning non-conductive parts with cloths. To prevent ignition sources from static discharges, earth continuity must be maintained to the spray gun and other metallic equipment used. It is essential to use conductive air and/or fluid hoses.



Personal Protective Equipment



Toxic vapours – When sprayed, certain materials may be poisonous, create irritation or be otherwise harmful to health. Always read all labels, safety data sheets and follow any recommendations for the material before spraying. If in doubt, contact your material supplier.



The use of respiratory protective equipment is recommended at all times. The type of equipment must be compatible with the material being sprayed.



Always wear eye protection when spraying or cleaning the spray gun.



Gloves must be worn when spraying or cleaning the equipment.

Training – Personnel should be given adequate training in the safe use of spraying equipment.

Misuse

Never aim a spray gun at any part of the body.

Never exceed the maximum recommended safe working pressure for the equipment.

The fitting of non-recommended or non-original spares may create hazards.

Before cleaning or maintenance, all pressure must be isolated and relieved from the equipment.

The product should be cleaned using a gun-washing machine, and should be removed and dried immediately after cleaning is completed. Prolonged exposure to cleaning solutions can cause damage to the product.

Noise Levels



The A-weighted sound level of spray guns may exceed 85 dB (A) depending on the set-up being used. Details of actual noise levels are available on request. It is recommended that ear protection is worn at all times when spraying.

Operating

Spray equipment using high pressures may be subject to recoil forces. Under certain circumstances, such forces could result in repetitive strain injury to the operator.

PARTS LIST

REF. NO.	DESCRIPTION	PART NO.	QTY	REF. NO.	DESCRIPTION	PART NO.	QTY
1	Air Cap Retaining Ring	-	1	32	Air Valve Poppet	-	1
2	Slip Ring	-	1	33	Air Valve Spring	-	1
3	Air Cap	-	1	34	Air Valve Spring Pad	-	1
5	Retaining Ring Seal	-	1	35	Air Valve Seal	SN-34-K5	1
6	Aircap & Ring	See chart 1 p13	1	36	Air Valve Assembly	SN-402-K	1
8	Fluid Nozzle	See chart 2 p13	1	*37	Trigger Stud Screw (T20 TORX)	-	1
9	Separator	SRIPRO-2-K5	1	38	Trigger	-	1
*12	Body Bushing Seal	-	1	*39	Trigger Stud	-	1
13	Body Bushing	-	1	40	Trigger, Stud & Screw Kit	SN-42-K	1
14	Body Bushing & Seal	SN-6-K	1	41	Stud and Screw kit	SPN-405-K5	1
15	Fluid Needle	See chart 2 p13	1	42	Air Inlet	SN-40-K	1
*16	Needle Spring	-	1	43	Colour ID Ring Kit (4 Colours)	SN-26-K4	1
*17	Needle Spring Pad	-	1	44	Airflow Valve	PRO-404-K	1
18	Fluid Adjusting Knob	-	1	45	Circlip	-	1
19	Fluid Adjusting Knob, Spring & Pad Kit	PRO-3-K	1	49	Spanner kit of 2	SRI-50-K2	1
*20	Retaining Clip	-	1	50	Funnel kit of 12	SRI-51-K12	1
21	Spreader Valve Body	-	1	51	Gravity Cup Kit	SRI-510	1
*22	Spreader Valve Seal	-	2	52	Drip Check Lid (kit of 5)	GFC-2-K5	1
23	Spreader Valve Adjusting Knob	-	1	53	Gravity Cup Lid	-	1
*24	Valve Pin	-	1	54	Gravity Cup	-	1
25	Spreader Valve Assembly	SRIPRO-401-K	1	55	Filter	SRI-42-K5	1
*26	Needle Packing	-	1	56	Air valve Service Tool	-	1
*27	Packing Spring	-	1	57	Torx Key	SPN-8-K2	1
28	Packing Nut	-	1				
29	Packing, Spring & Packing Nut Kit	SN-404-K	1	SERVICE PARTS			
30	Air Valve Body	-		Spray Gun repair kit (includes items marked *)		PRO-415-1	
31	Air Valve Cage	-	1	Seal and Pin Kit, kit of 5 (items 20, 22 and 24)		GTI-428-K5	
				For accessories, see page 13			

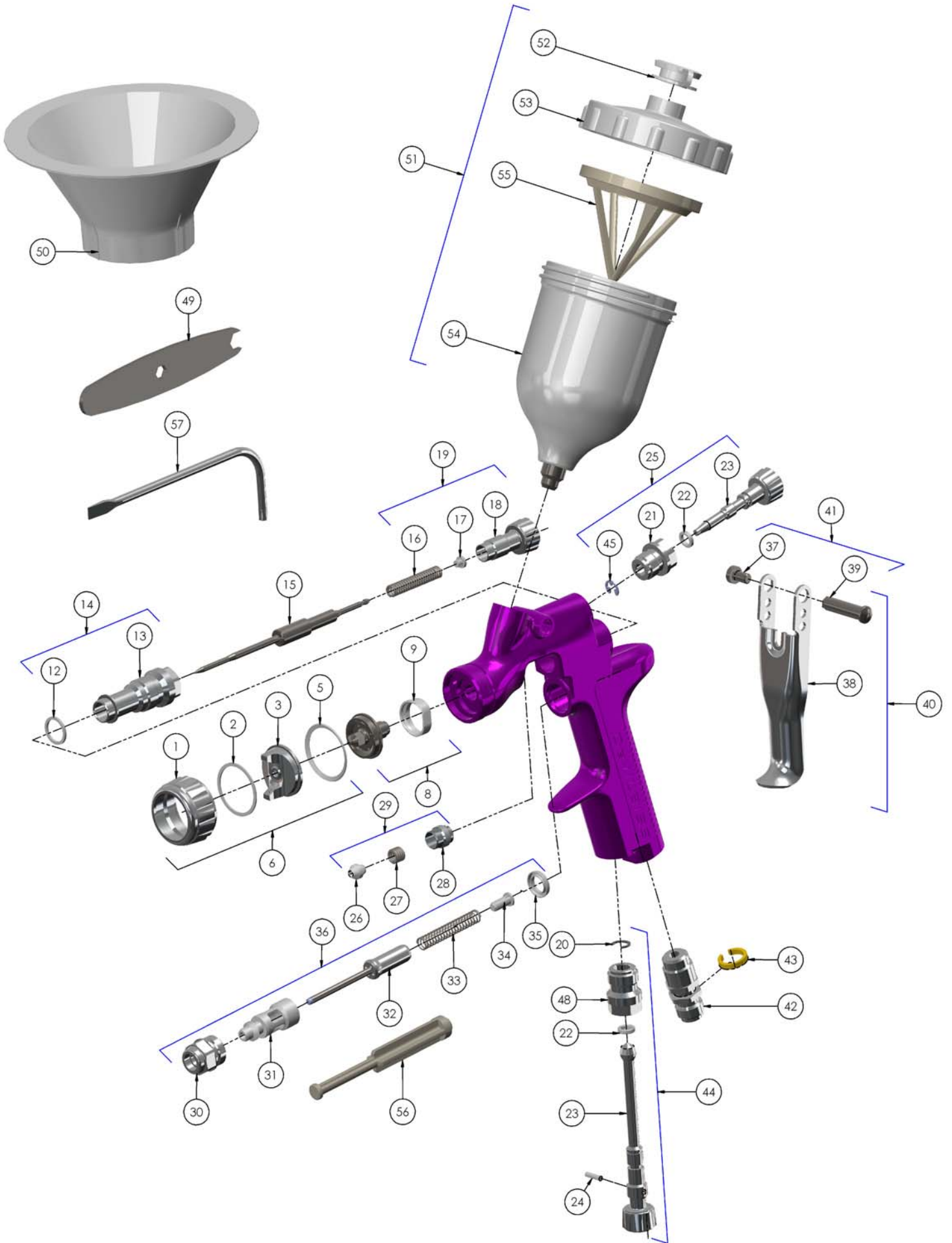

INSTALLATION

For maximum transfer efficiency, do not use more pressure than is necessary to atomise the material being applied. **NOTE: when using the HS1, HVLP setup do not exceed 2 bar inlet pressure.**

1. Connect the gun to a clean, moisture and oil free air supply using a conductive hose.

NOTE

Install an air gauge at the gun handle. When gun is triggered on, adjust regulated pressure to 2.0 bar. Do not use more pressure than is necessary to atomise the material being applied. Excess pressure will create additional overspray and reduce transfer efficiency.

NOTE

If an air adjusting valve is used at the gun inlet, use DGI-501-bar Digital Gauge. Some competitive adjusting valves have significant pressure drop that can adversely affect spray performance. The DGI Digital Gauge has minimal pressure drop, which is important for HVLP spraying.

2. Attach the gravity feed cup to the material inlet.

NOTE

Before using the gun, flush it with solvent to ensure that the fluid passages are clean.

OPERATION

1. Mix coating material to manufacturer's instructions.
2. If required, fit the filter (55) in the cup (54) or use the funnel (50) with a paper filter.
3. Fill the cup to no more than 5 mm from the top of the cup. **DO NOT OVERFILL.**
4. Attach Cup Lid.
5. Turn fluid adjusting knob (18) clockwise to prevent fluid needle movement.
6. Turn spreader valve adjusting knob (23) counter clockwise to fully open.
7. Adjust inlet air pressure to 2.0 bar.
8. Turn fluid adjusting knob counter clockwise until first thread shows.
9. Test spray. If the finish is too dry, reduce airflow by reducing air inlet pressure.
10. If finish is too wet, reduce fluid flow by turning fluid adjusting knob (18) clockwise. If atomisation is too coarse, increase inlet air pressure. If too fine, reduce inlet pressure.
11. The pattern size can be reduced by turning spreader valve knob (23) clockwise.
12. Hold gun perpendicular to surface being sprayed. Arcing or tilting may result in uneven coating.
13. The recommended spray distance is 75-150 mm.
14. Spray edges first. Overlap each stroke a minimum of 75%. Move gun at a constant speed.

15. Always turn off air supply and relieve pressure when gun is not in use.

PREVENTIVE MAINTENANCE & CLEANING

To clean air cap and fluid nozzle, brush exterior with a stiff bristle brush. If necessary to clean cap holes, use a broom straw or toothpick if possible. If a wire or hard instrument is used, extreme care must be used to prevent scratching or burring of the holes which will cause a distorted spray pattern.

To clean fluid passages, remove excess material from cup, then flush with gun wash solution. Wipe the gun exterior with a dampened cloth. Never completely immerse in any solvent or cleaning solutions as this is detrimental to the lubricants and life of the spray gun.

NOTE

When replacing the fluid nozzle or fluid needle, replace both at the same time. Using worn parts can cause fluid leakage. See page 13, Chart 2. Also, replace the needle packing at this time. Torque the fluid nozzle to 9–10 nm. Do not over tighten.

CAUTION

To prevent damage to fluid nozzle (8) or fluid needle (15), be sure to either 1) pull the trigger and hold while tightening or loosening the fluid nozzle, or 2) remove fluid adjusting knob (18) to relieve spring pressure against needle collar.

CAUTION

IMPORTANT– the Gravity cup is made from special anti-static materials, but it still important to avoid generating static charges. The Cup must not be cleaned or rubbed with a dry cloth or paper. It is possible to generate a static charge by rubbing which, if discharged to an earthed object could create an incendive spark and cause solvent vapours to ignite. Only use a dampened cloth or antistatic wipes if manual cleaning is required within a hazardous area.

Parts Replacement/Maintenance

AIR VALVE INSTRUCTIONS

Servicing Air Valve

Reasons to service air valve:

- A) Air valve not functioning correctly (may need cleaning).
 - B) Routine maintenance.
 - C) Air leaks (advise replacement, see p10)
1. Remove trigger using the tool supplied (SPN-8) or TORX T20 key. (See fig 1 & 2)
 2. Unscrew air valve using SN-28 (14 mm) spanner. (See fig 3)
 3. Remove air valve by gripping stem. (See fig 4)
 4. Remove spring with spring pad. (See fig 5)
 5. DO NOT REMOVE REAR SEAL (35) FROM GUN BODY. (See fig 6)
 6. DO NOT REMOVE PLASTIC CAGE FROM AIR VALVE BODY AS THIS MAY DAMAGE THE CAGE. (See fig 7)
 7. CLEAN
 - a. Remove all paint build up. (See fig 8)
 - b. The 4 poppet holes must be clear. (See fig 9)
 - c. Stem must be free to float in poppet. (See fig 10)
 - d. Stem must slide through cage bore with slight resistance (due to seal).
 - e. Rear seal must look clean and in position in the bore. (See fig 6)
 - f. If any of the above cannot be rectified, replace the air valve (See Replacing Air Valve p10).
 8. Replace spring ensuring the end with the plastic bearing pad goes in first. (See fig 5)
 9. Insert air valve assembly into gun and carefully feed over the spring and through the rear seal. (See fig 11)
 10. Tighten air valve assembly using fingers first, and then tighten with SN-28 (14mm) Spanner. (See figs 12 & 3)
 11. Replace trigger. (See figs 2 & 1)
 12. If there is an air leak through the gun, the air valve may need replacing (See Replacing Air Valve).

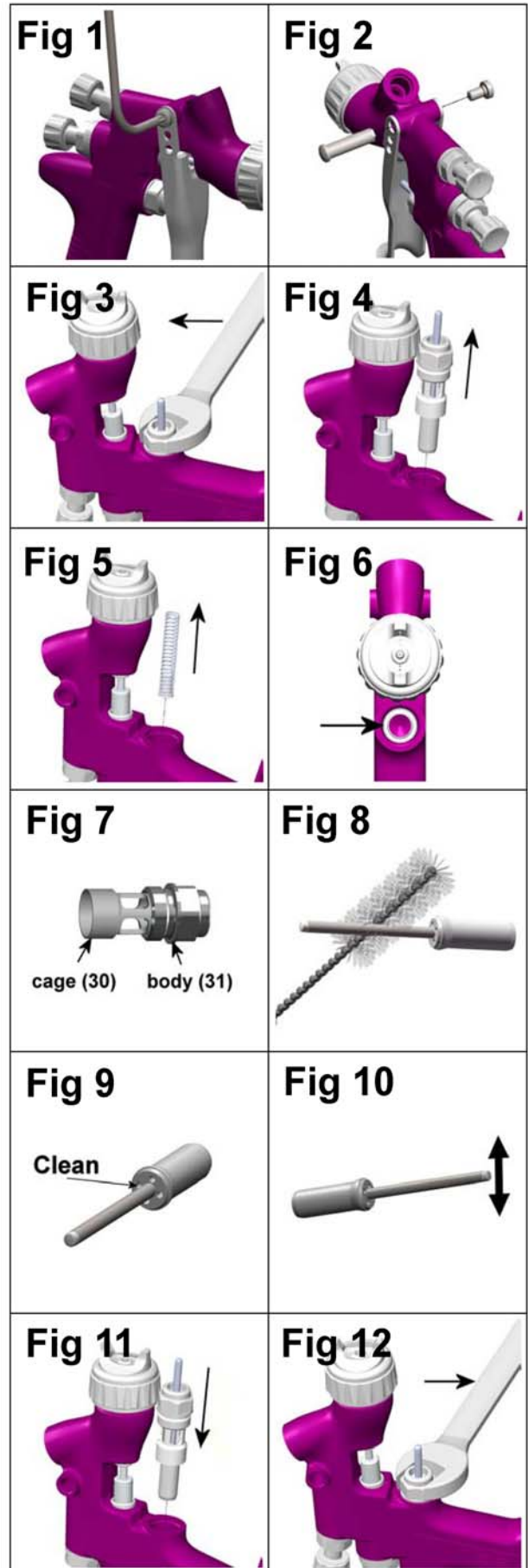

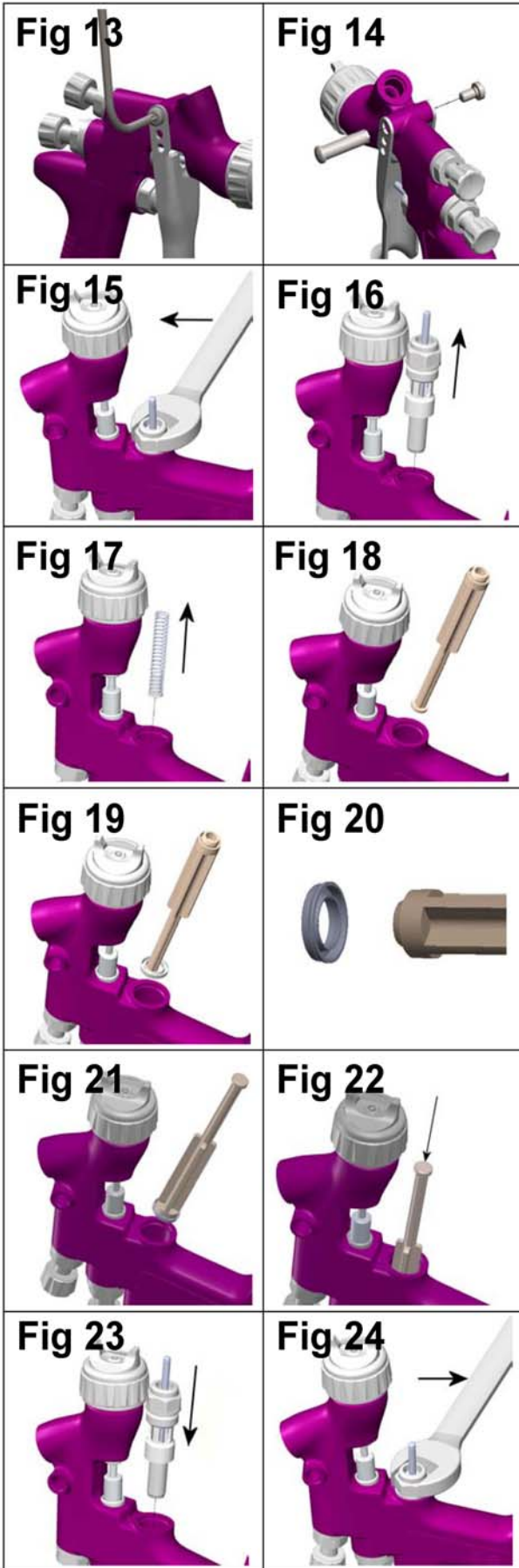

Replacing Air Valve

Reasons to replace air valve:

- A) Air leak through the gun.
- B) Air valve not operating correctly.

1. Remove trigger using SPN-8 or TORX (T20) key provided in the kit. (See figs 13 & 14)
2. Unscrew air valve using SN-28 (14 mm) Spanner. (See fig 15)
3. Remove air valve by gripping the stem. (See fig 16)
4. Remove spring with spring pad. (See fig 17)
5. Hook out rear seal using Service Tool (56). (See figs 18 & 19)
6. Clean air valve bores in gun body with the brush supplied in the kit.
7. Place new rear seal onto Service tool (56); grooves must fit in service tool form. (See fig 20)
8. Push rear seal firmly into hole up to shoulder, using Service tool. (See figs 21 & 22)
9. Insert new spring, ensuring the end with the plastic bearing pad goes in first. (See fig 17)
10. Insert air valve assembly into gun and carefully feed over the spring and through the rear seal. (See fig 23)
11. Tighten air valve assembly using fingers first, then tighten with SN-28 (14 mm) Spanner. (See figs 24 & 15)
12. Replace trigger. (See figs 14 & 13)

Parts Replacement/Maintenance

NEEDLE PACKING

REPLACEMENT INSTRUCTIONS

13. Remove trigger using SPN-8 (57) or TORX (T20) driver. (See figs 25 & 26)
14. Remove fluid adjusting knob and needle spring with spring pad from gun. (See figs 27 & 28)
15. Remove fluid needle from gun body. (See fig 29)
16. Loosen and remove packing nut using SPN-8 (57) Key or a straight blade screwdriver. (See figs 30 & 31)
17. Discard old packing and packing spring if replacing. Clean packing if reusing. Also clean packing spring and nut. (See fig 32).
18. Re-assemble the packing, (See fig 32). Assemble into gunbody by hand (see fig 33) and then tighten. (See figs 30 and 31)
19. Insert fluid needle all the way into gun body seating in fluid nozzle (See fig 34).
20. Insert needle spring, spring pad, and fluid adjusting knob. (See figs 28 & 27). Reinstall trigger. (See figs 25 & 26).
21. Trigger gun fully and screw in fluid adjusting knob until it stops. Back it off 1/2 turn and gun will have full needle travel.
22. Trigger gun several times to verify correct operation.

SPREADER VALVE ASSEMBLY

REPLACEMENT/MAINTENANCE

The spreader valve assembly can be replaced if damaged. Remove using SN-28 (14 mm) Spanner (See figs 35 & 36). The internal seal can be replaced and is included in the PRO Gun Rebuild Kit.

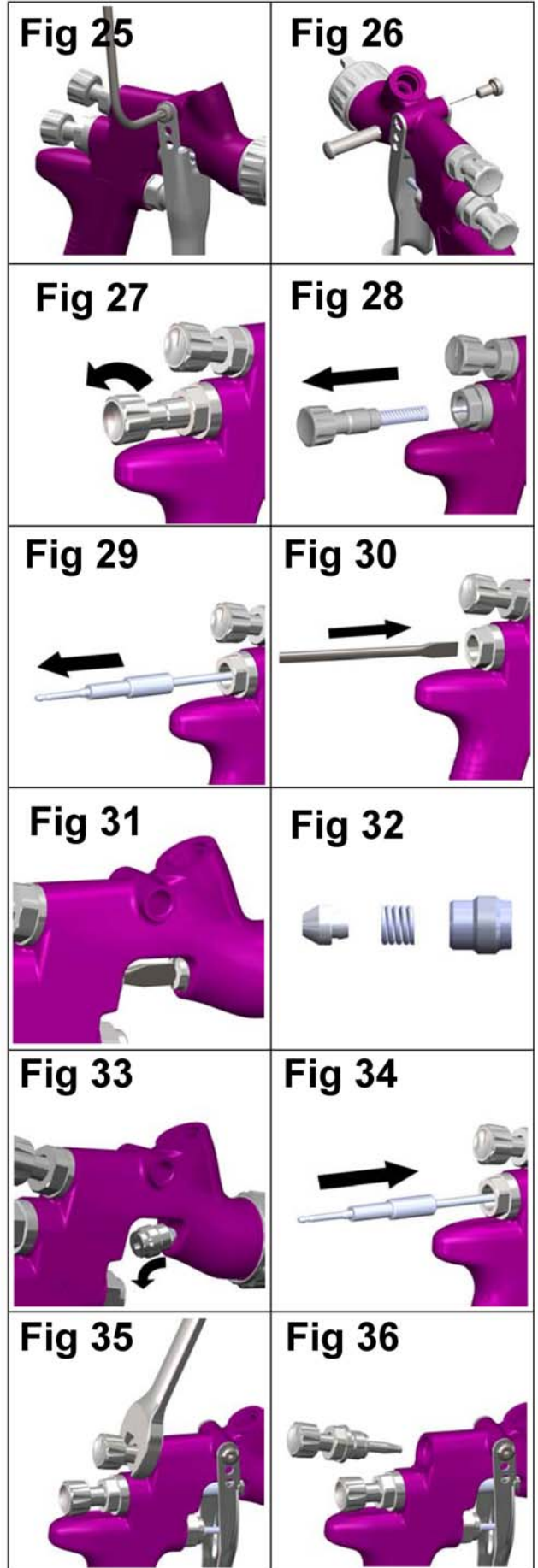

Parts Replacement/ Maintenance

SEPARATOR SEAL REPLACEMENT

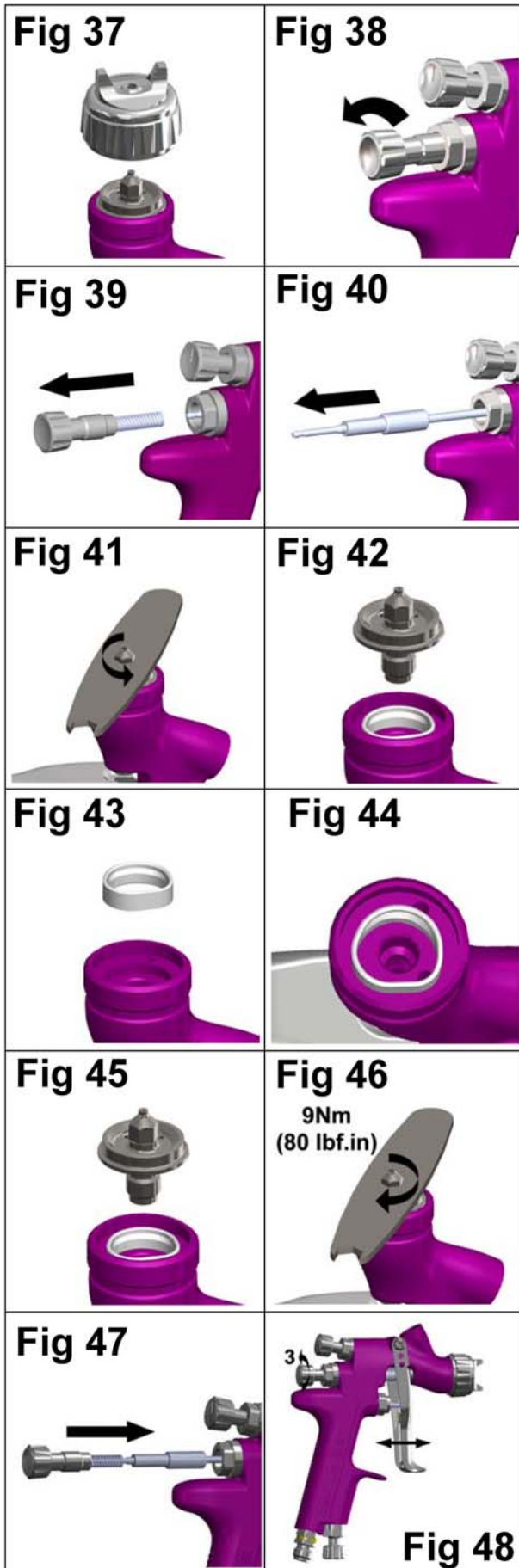

1. Remove air cap and retaining ring. (See fig 37)
2. Remove fluid adjusting knob, spring, and spring pad. (See figs 38 & 39)
3. Remove fluid needle from gun body. (See fig 40)
4. Remove fluid nozzle using SRI-50 (8 mm) Spanner. (See figs 41, & 42)
5. Remove Separator. (See fig 43).
6. Clean front of gun if required, using a soft brush, as well as the fluid nozzle, air cap, and retaining ring.
7. Place a new Separator Seal into the front of the gun, making sure the flat side of the seal is aligned with the flat in the gun. (See fig 44).
8. Fit Fluid Nozzle, Air Cap, and Retaining Ring. Torque the Fluid Nozzle to 9–10 Nm (80–90 lbs.in). Don't over torque the Fluid Nozzle. (See figs 45, 46, and 37)
9. Insert Fluid Needle all the way into the Gun Body, seating in the Fluid Nozzle. (See fig 47)
10. Reassemble Needle Spring, Spring Pad, and Fluid adjusting Knob. (See fig 47)
11. Trigger gun fully and screw in Fluid Adjusting Knob until it stops. Back it off 3 turns and gun will have full needle travel.
12. Trigger gun several times to verify correct operation (see fig 48).

Parts Replacement/Maintenance

Chart 1 – Air Caps

PART No. FOR AIR CAP	TECHNOLOGY	MARKING ON AIR CAP	RECOMMENDED INLET PRESSURE (bar)	AIR FLOW (L/min)
SRIPRO-100-HS1-K	HVLP	HS1	2.0	135
SRIPRO-100-TS1-K	TRANS-TECH®	TS1	2.0	100
SRIPRO-100-RS1-K	TRANS-TECH®	RS1	1.0	55

NOTE: When removing air cap from retaining ring, don't remove the Slip Ring (2) or Retaining Ring Seal (5) from the Retaining Ring. Damage to the parts may occur. Slip ring and Retaining Ring seal are not available as replacements. Simply wipe parts clean and reassemble with new or clean air cap.

Chart 2 – Fluid Nozzle Range & Fluid Needle

PART No. ON FLUID NOZZLE	PART No. NEEDLE
SRIPRO-200-08-K	SRIPRO-300-08-10-K
SRIPRO-200-10-K	
SRIPRO-200-12-K	SRIPRO-300-12-14-K
SRIPRO-200-14-K	

NOTE: When replacing the fluid nozzle or fluid needle, replace both at the same time. Torque to 9–10 Nm (80–90 lbs.in). Don't over tighten the fluid nozzle. Use SRI-50 6mm Spanner supplied with the gun and check with a torque wrench.





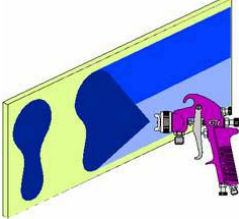
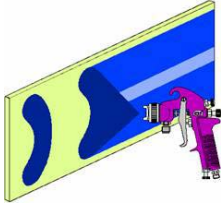
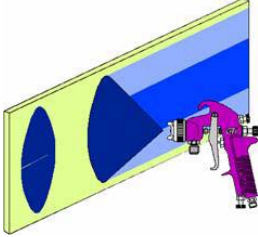
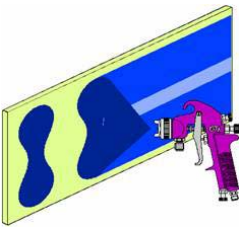
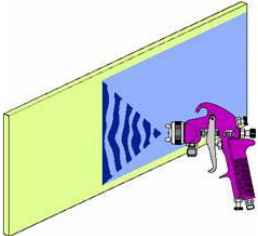





IMPORTANT NOTE: The SRI PRO and old SRI tips and aircaps ARE NOT INTERCHANGEABLE between the 2 models. Any attempt to fit tips or caps onto the wrong Spray Gun may cause damage to the parts or the Spraygun body and invalidate the warranty.

Troubleshooting Possible Problems in Operation

CONDITION	CAUSE	CORRECTION
<p>Heavy top or bottom pattern</p>  <p>Heavy right or left side pattern</p> 	<p>Horn holes plugged.</p> <p>Obstruction on top or bottom of fluid nozzle.</p> <p>Cap and/or nozzle seat dirty.</p> <p>Left or right side horn holes plugged.</p> <p>Dirt on left or right side of fluid nozzle.</p>	<p>Clean. Ream with non-metallic point.</p> <p>Clean.</p> <p>Clean.</p> <p>Clean. Ream with non-metallic point.</p> <p>Clean.</p>
<p>Remedies for the top-heavy, bottom-heavy, right-heavy, and left-heavy patterns:</p> <p>1. Determine if the obstruction is on the air cap or the fluid nozzle. Do this by making a test spray pattern. Then, rotate the cap one-half turn and spray another pattern. If the defect is inverted, obstruction is on the air cap. Clean the air cap as previously instructed. Also check for dried paint just inside the cap center hole opening; remove by washing with solvent.</p> <p>2. If the defect is not inverted, it is on the fluid nozzle. Clean nozzle. If problem persists, renew nozzle.</p>		
<p>Heavy centre pattern</p> 	<p>Spreader adjustment valve set too low.</p> <p>Atomising pressure too low.</p> <p>Material too thick.</p>	<p>Turn out counter clockwise to achieve correct pattern.</p> <p>Increase pressure.</p> <p>Thin to correct consistency.</p>
<p>Split spray pattern</p> 	<p>Air pressure too high.</p> <p>Fluid adjusting knob turned in too far.</p> <p>Spreader adjusting valve set too high.</p>	<p>Reduce at regulator or gun handle.</p> <p>Turn out counter clockwise to achieve correct pattern.</p> <p>Turn in clockwise to achieve correct pattern.</p>
<p>Jerky or fluttering spray</p> 	<p>Loose or damaged fluid nozzle/seat</p> <p>Loose or broken cup fluid nipple</p> <p>Material level too low</p> <p>Container tipped too far</p> <p>Obstruction in fluid passage</p> <p>Loose fluid needle packing nut</p> <p>Damaged fluid needle packing</p>	<p>Tighten or replace</p> <p>Tighten or replace cup</p> <p>Refill</p> <p>Hold more upright</p> <p>Back flush with solvent</p> <p>Tighten</p> <p>Replace</p>
<p>Paint bubbles in cup</p>	<p>Fluid nozzle not tight.</p>	<p>Fluid nozzle not tight. Tighten to 14–16 nm (10-12 ft-lbs).</p>
<p>Fluid leaking or dripping from cup lid</p>	<p>Cup lid loose.</p> <p>Dirty cup or lid.</p> <p>Cracked cup or lid.</p>	<p>Push in or replace.</p> <p>Clean.</p> <p>Replace cup and lid.</p>

Troubleshooting Possible Problems in Operation (cont)

Starved spray pattern	Inadequate material flow Blocked vent in Cup lid Low atomisation air pressure	Wind fluid adjusting knob out or change to larger fluid nozzle size Clean lid and unblock vent Increase air pressure and rebalance gun.
Excessive overspray	Air pressure too high. Gun too far from work surface.	Reduce air pressure. Adjust to correct distance.
Dry spray	Air pressure too high. Gun too far from work surface. Gun motion too fast. Fluid flow too low.	Reduce air pressure. Adjust to correct distance. Slow down. Wind out needle adjusting screw or use larger nozzle size.
Fluid leaking from packing nut	Packing worn.	Replace.
Fluid leaking or dripping from front of gun	Fluid nozzle or fluid needle worn or damaged. Foreign matter in fluid nozzle. Fluid needle dirty or stuck in needle packing Wrong size fluid needle or fluid nozzle.	Replace fluid nozzle and fluid needle. Clean. Clean Replace fluid nozzle and fluid needle.
Fluid dripping or leaking from bottom of cup	Cup loose on gun. Cup fluid inlet seat dirty.	Tighten Clean.
Runs and sags	Too much material flow. Material too thin. Gun tilted on an angle, or gun motion too slow.	Turn fluid adjusting knob clockwise or switch to smaller fluid nozzle and fluid needle size. Mix correctly or apply light coats. Hold gun at right angle to work and adapt to correct gun technique.

ACCESSORIES					
DGi Digital Pressure Gauge	DGI-501-BAR		Gun Stand	GFV-50-F	
Spanner	SN-28-K		MC-1-K50	600 cc Mixing Cups pack of 50	
Torx driver	SPN-8-K2		10m x 8mm bore rubber air hose with 1/4 fittings	H-6065-B (BSP) H-6065-N (NPS)	
MPV Swivel	MPV-60-K3		Pack of four QD fittings	MPV-463	
Cleaning Brush	4900-5-1-K3		Disposable Cup, Kit of 12	SRI-479-K12	

WARRANTY

This product is covered by ITW Finishing Systems and Products Limited one year warranty.

ITW Finishing Systems and Products
Ringwood Road,
Bournemouth,
BH11 9LH, UK
Tel. No. (01202) 571111
Telefax No. (01202) 581940,
Website address <http://www.devilbisseu.com>

ITW Oberflächentechnik GmbH & Co. KG
Justus-von-Liebig-Straße 31
63128 Dietzenbach
Tel (060 74) 403-1
Telefax: (060 74) 403300
Website address <http://www.devilbisseu.com>

ITW Automotive Finishing UK
Anchorbrook Industrial Estate
Lockside
Aldridge,
Walsall, UK.
Tel. No. (01922) 423700
Telefax No. (01922) 423705,
Website address <http://www.itweuropeanfinishing.com>

ITW Surfaces Et Finitions
163-171 avenue des Auréats B.P. 1453
26014 VALENCE CEDEX FRANCE
Tél. (33) 475-75-27-00
Télex 345 719F DVILBIS
Téléfax: (33) 475-75-27-99
<http://www.devilbisseu.com>

ITW Finishing Systems and Products is a Division of ITW Ltd. Reg. Office: Admiral House, St Leonard's Road, Windsor, Berkshire, SL4 3BL, UK. Registered in England: No 559693 Vat No 619 5461 24